

MRV5

DC INVERTER

011 Features & Benefits

016 MRV 5 Outdoor

029 Dimensions





ADVANCED TECHNOLOGY

Smart link

Wireless connection and communication between indoor units.

- Labor saving
- Automatic network connection
- Convenient maintenance
- Stable performance
- Total Cost saving is about 30%



ADVANCED TECHNOLOGY

Total pipe length 1000m, height drop 110m

- Max. total pipe length 1000m
- Max. actual pipe length 220m
- Max. equivalent pipe length 260m
- Max. drop between IDU&ODU / 90m (outdoor unit up) / 110m (outdoor unit down)
- Max. drop between IDU&IDU 30m*

* if the total pipe length is between 300m and 1100m or the drop between IDU and ODU more than 50m, please contact your local dealer.

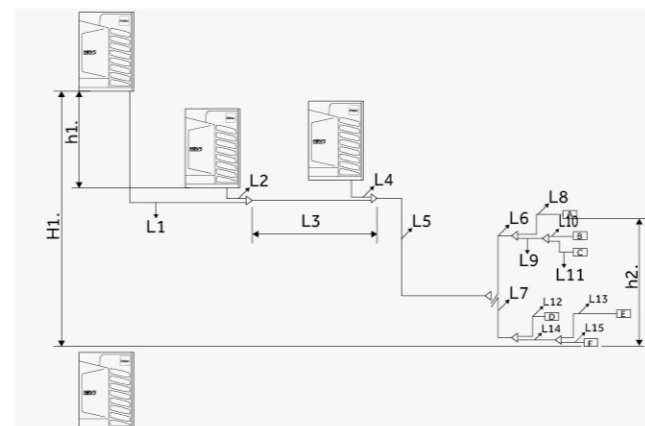
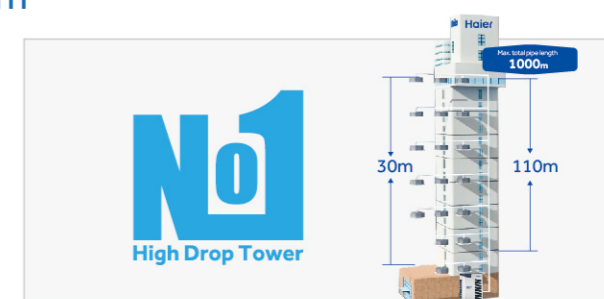

	Max. length	Pipe in left figure	
Single way total pipe length (=total liquid pipe length)	1000m	L1+L2+L3+L4+L5+L6+L7+L8+L9+L10+L11+L12+L13+L14+L15	
Single way max. pipe length (max. length between outdoor & indoor) actual length	220m	L1+L3+L5+L7+L14+L13	
Main pipe actual length (length between first gather pipe & first branch pipe)	130m	L5	
Pipe length after first branch pipe (length between first branch & farthest indoor)	90m	L7+L13+L14	
The distance between the nearest indoor unit and the farthest indoor	40m	L13+L14-L12	
Pipe length among outdoor units (length between first gather pipe & farthest outdoor unit)	10m	L1+L3	
Height difference between indoors	18m	h2	
Height difference between outdoors	5m	h1	
Height difference between indoor & outdoor	Indoor below outdoor (between highest outdoor & lowest indoor)	50m	H1
	Indoor above outdoor (between lowest outdoor & highest indoor)	40m	H2

Design of control condenser with electronic expansion valve

The condenser is controlled by two electronic expansion valves respectively, which can reasonably use the heat exchanger area according to the demand of IDU heat exchange temperature, distribute the refrigerant flow according to the load demand, to ensure high-performance heat exchange efficiency.

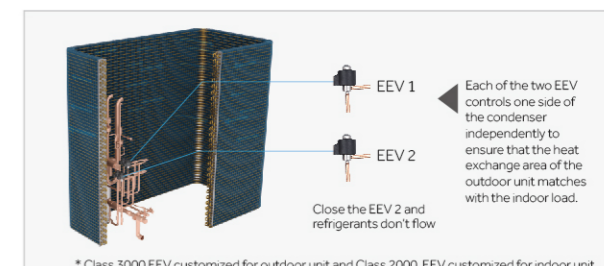

HIGH EFFICIENCY

Super efficiency with full DC inverter compressor

Exhaust temperature sensor

Soft scroll plate design, compared with the common scroll plate, it reduce the leakage loss and mechanical loss, more efficiency

The soft structure and overpressure protection of unloading valve, both of them can effectively reduce stress loss. The compressor is more stable and also efficiency

We adopted High pressure chamber compressor, and low oil rate structure design, to ensure the reliable oil supply of the compressor, and lubricate all parts effectively

Adopt new type oil cup design, reduce the disturbance of high speed rotation to oil level, also reduce the oil discharge, improve lubrication efficiency, reduce frictional loss

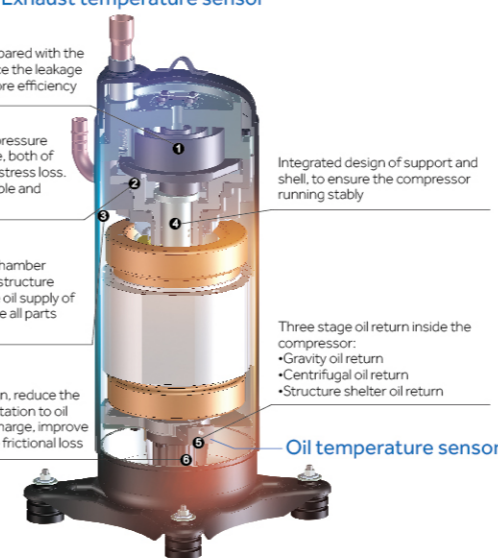

Matches up inverter with step less compressor, the durability and stability of the compressor are guaranteed, fault can be reduced.

Each compressor is adopted oil temperature sensor and the discharge temperature sensor, detecting the discharge temperature and oil temperature of compressor, cooperated with the compressor frequency and the EEV control, to ensure exhaust heat and oil temperature superheat kept within the optimal range. Ensure that the oil dilution is maintained at a safe level at all times.

HIGH EFFICIENCY

Speedless inverter DC-motor

Outdoor unit matches efficient variable-speed DC-motor, driven by sine wave, wider efficiency range and torque range, motor efficiency is increased by 17%. air fan of outdoor unit can achieve 0-91Hz stepless frequency.



New one-piece of four-way heat exchanger

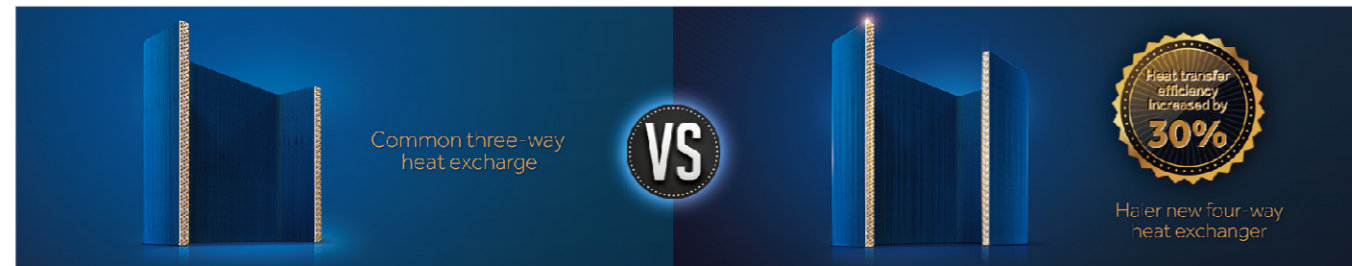

Temperature approaching technology

The main problem of an ordinary inverter VRF system lies in that its compressor starts and stops frequently, stopping when the room temperature reaches the setting temperature and restarting when the same becomes higher than the setting temperature. Though the inverter technology has improved such a problem greatly, the energy consumption caused by system restart is still a problem that cannot be ignored. Haier MRV 5 series units adopts the temperature approaching technology, which enables the VRF system to maintain a low-frequency operating state all the time when the room temperature is close to the setting temperature but don't reach the setting temperature, thus avoiding the energy waste caused by frequent on/off.

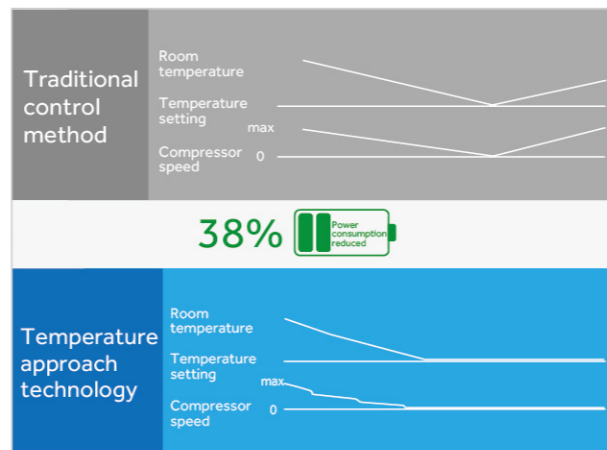

SUPER COMFORT

Wide operation temperature

The heating operation temperature can be as low as -23°C, and the heating is more powerful in winter. The cooling operation temperature can reach 50°C, better in summer.



Precise temperature control at ±0.5°C

With twin pressure sensors and twin EEVS, the refrigerant volume can be adjusted automatically to realize precise temperature control, improving indoor comfort.



SUPER COMFORT

Intelligent triple backup operation technology

- For the double-compressor system, when one compressor breakdown, the other compressor can be put into backup operation immediately to ensure the user needs.
- For the multi-module combination, in case of breakdown of one outdoor unit, this unit can be interrupted from the system so that the other modules can continue to operate.
- Super-long backup operation time, which can reach up to 8 hours.



Multiple modes available to meet the needs of different users



Operation mode: Cooling priority, heating priority, cooling only, heating only, and VIP priority



Silent mode: Seven-position silent mode available (nighttime silent mode and six-position silent mode)



Static pressure mode: No static pressure mode, low static pressure mode, medium static pressure mode, and high static pressure mode

Rotary electric control box design

Rotary electric control box design, while maintaining the internal space, maintainers only need to rotate the box, do not need to dismantle the box, easy and fast maintenance.



EASY INSTALLATION

4-way pipe connection

You can freely choose the front, back, left side, right side of the unit to connect the pipe, easy to install and design.

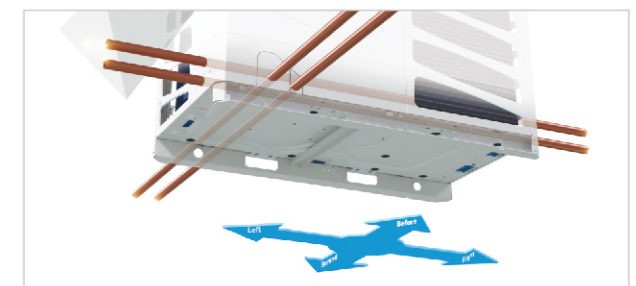

EASY INSTALLATION

Auto addressing indoor units

The ODU can automatically address to the indoor unit through the module on PCB, and the controller can search and set the address of the indoor unit, more convenient.



Automatic oil balancing

Without oil balancing pipe, the oil is balanced automatically. This simplifies system design and improves reliability.

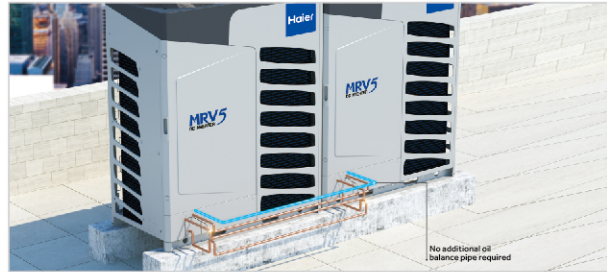

Automatic snow clearing and dust removal function

According to the ash accumulation on the outdoor heat exchanger, the unit will blow away the dust, according to the reverse operation of the fan.



Piping refrigerant storage technology

Advanced refrigerant control technology, the refrigerant is stored in the indoor and outdoor machine piping, remove the high pressure tank, less refrigerant filling in unit, high efficiency.

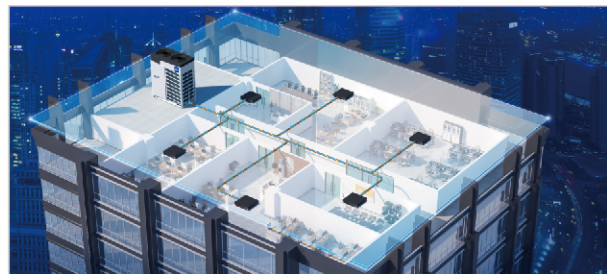

110Pa external static pressure design

The static pressure of the air outlet is up to 110Pa, which can meet the cooling effect of the layered arrangement of the outdoor unit.



Installation of duct

The outdoor unit is hidden inside the building without affecting the overall image of the building

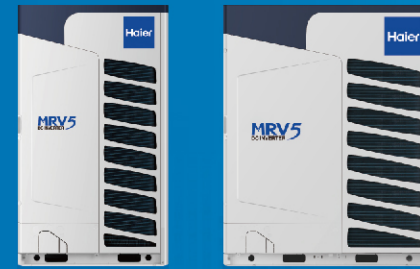

AV08IMVEVA
AV10IMVEVA
AV12IMVEVA
AV14IMVEVA
AV16IMVEVA

AV18IMVEVA
AV20IMVEVA
AV22IMVEVA
AV24IMVEVA
AV26IMVEVA

3/380~415/50/60



Model		AV08IMVEVA	AV10IMVEVA	AV12IMVEVA	AV14IMVEVA	AV16IMVEVA	
Capacity	Combination model		/	/	/	/	
			/	/	/	/	
			/	/	/	/	
			/	/	/	/	
			/	/	/	/	
Capacity	Capacity range	HP	8	10	12	14	
	Cooling	kW	25.2	28.0	33.5	40.0	
	Heating	kW	25.2	28.0	33.5	40.0	
Electrical parameters	Power supply	Ph/V/Hz	3/380-415/50/60	3/380-415/50/60	3/380-415/50/60	3/380-415/50/60	
	Cooling	Rated power input	kW	6.24	7.37	9.31	11.94
		Max power input	kW	12.00	12.90	13.80	16.40
		Rated current	A	10.53	12.44	15.71	20.16
		Max current	A	20.26	21.78	23.30	27.69
	Heating	Rated power input	kW	5.73	6.51	7.94	10.00
		Max power input	kW	10.90	12.20	12.50	15.10
		Rated current	A	9.67	10.99	13.41	16.88
		Max current	A	18.40	20.60	21.10	25.49
	SEER			7.25	7.09	6.69	6.60
	SCOP			4.50	4.40	4.40	4.20
	ηs.c	%		287	281	265	261
ηs.h	%		177	173	173	165	
Performance	Air flow (H)	m³/h	11000	11000	12000	13500	
	Sound pressure level (H)	dB(A)	56	56	59	59	
Installation	External dimensions(W/D/H)	mm	980/750/1690				
	Shipping dimensions(W/D/H)	mm	1070/850/1858				
	Net/Shipping weight	kg	224/250		244/270		
	Compressor type		DC INV. SCROLL	DC INV. SCROLL	DC INV. SCROLL	DC INV. SCROLL	
	Compressor brand		MITSUBISHI	MITSUBISHI	MITSUBISHI	MITSUBISHI	
			ELECTRIC	ELECTRIC	ELECTRIC	ELECTRIC	
	Compressor quantity		1INV	1INV	1INV	1INV	
	Refrigerant type		R410A	R410A	R410A	R410A	
	Refrigerant charge	kg	8.5	8.5	8.5	10	
	Refrigerant liquid pipe	mm	9.52	9.52	12.7	12.7	
	Refrigerant gas pipe	mm	19.05	22.22	25.4	25.4	
	Max.total pipe length	m	1000	1000	1000	1000	
	Max. pipe length (Equivalent/Actual)	m	260/220	260/220	260/220	260/220	
	Max drop between I.U.&O.U. (O.U. down/up) *1	m	110/90	110/90	110/90	110/90	
	Standard drop between I.U.&O.U. (O.U. up/down) *2	m	50/40	50/40	50/40	50/40	
Max drop between I.U. *3	m	30	30	30	30		
Standard drop between I.U. *4	m	18	18	18	18		
External static pressure	Pa	110	110	110	110		
Connection ratio	Connectable indoor unit ratio	%	50-130	50-130	50-130	50-130	
	Maximum number of indoor units		13	16	20	27	
Working temp.	Cooling	°C	-5-50				
	Heating	°C	-23-21				

Max drop between I.U.&O.U. *1
Standard drop between I.U.&O.U. *2
Max drop between I.U. *3
Standard drop between I.U. *4
* All the specifications are tested under nominal condition in cooling. Indoor temp. is 27°C DB/19°C WB; Outdoor temp. is 35°C DB/24°C WB in heating. Indoor temp. is 20°C DB in heating. Outdoor temp. is 7°C DB/6°C WB

If the height difference between the outdoor and the indoor units is from 50 to 110m, you MUST contact your local distributor/dealer for individual design and production.
Standard design and production in the factory.
If the height difference between the indoor units is from 18 to 30m, you MUST contact your local distributor/dealer for individual design and production.
Standard design and production in the factory.

MRV5 DC INVERTER



3/380~415/50/60



AV08IMVEVA
AV10IMVEVA
AV12IMVEVA
AV14IMVEVA
AV16IMVEVA



AV18IMVEVA
AV20IMVEVA
AV22IMVEVA
AV24IMVEVA
AV26IMVEVA



Model			AV18IMVEVA	AV20IMVEVA	AV22IMVEVA	AV24IMVEVA	AV26IMVEVA	AV28IMVEVA	AV30IMVEVA	AV32IMVEVA	
Combination model			/	/	/	/	/	AV14IMVEVA	AV14IMVEVA	AV16IMVEVA	
			/	/	/	/	/	AV14IMVEVA	AV16IMVEVA	AV16IMVEVA	
			/	/	/	/	/	/	/	/	
			/	/	/	/	/	/	/	/	
Capacity	Capacity range	HP	18	20	22	24	26	28	30	32	
	Cooling	kW	50.4	56.0	61.5	68.0	73.5	80.0	85.0	90.0	
	Heating	kW	50.4	56.0	61.5	68.0	73.5	80.0	85.0	90.0	
Electrical parameters	Power supply	Ph/V/Hz	3/380-415/50/60	3/380-415/50/60	3/380-415/50/60	3/380-415/50/60	3/380-415/50/60	3/380-415/50/60	3/380-415/50/60	3/380-415/50/60	
	Cooling	Rated power input	kW	15.70	16.62	18.30	21.94	24.75	23.88	25.18	26.47
		Max power input	kW	21.40	25.10	28.50	29.10	33.00	32.80	35.60	38.40
		Rated current	A	26.51	28.05	30.90	37.03	41.78	40.32	42.50	44.69
		Max current	A	36.13	42.37	48.11	49.13	55.80	55.37	60.10	64.83
	Heating	Rated power input	kW	13.19	14.66	16.62	19.43	22.27	20.00	21.25	22.50
		Max power input	kW	17.70	22.70	25.50	26.50	30.40	30.20	33.50	36.80
		Rated current	A	22.27	24.75	28.06	32.80	37.60	33.76	35.87	37.98
		Max current	A	29.88	38.32	43.05	44.74	51.32	50.98	56.55	62.13
	SEER		6.78	6.75	6.54	5.97	5.68	6.60	6.47	6.36	
SCOP		4.23	4.29	4.30	4.25	3.80	4.17	4.08	4.01		
ηs.c	%	268	267	259	236	224	261	256	252		
ηs.h	%	166	169	169	167	149	164	160	157		
Performance	Air flow (H)	m³/h	17000	17000	18000	18000	19000	27000	27000	27000	
	Sound pressure level (H)	dB(A)	61	61	61	62	62	62	62.5	63	
Installation	External dimensions(W/D/H)	mm	1410/750/1690			1410/750/1690			980/750/1690+980/750/1690		
	Shipping dimensions(W/D/H)	mm	1515/850/1858			1515/850/1858			1070/850/1858+1070/850/1858		
	Net/Shipping weight	kg	287/317			370/400			244/270+244/270	244/270+244/270	
	Compressor type		DC INV. SCROLL	DC INV. SCROLL	DC INV. SCROLL	DC INV. SCROLL	DC INV. SCROLL	DC INV. SCROLL	DC INV. SCROLL	DC INV. SCROLL	
	Compressor brand		MITSUBISHI ELECTRIC	MITSUBISHI ELECTRIC	MITSUBISHI ELECTRIC	MITSUBISHI ELECTRIC	MITSUBISHI ELECTRIC	MITSUBISHI ELECTRIC	MITSUBISHI ELECTRIC	MITSUBISHI ELECTRIC	
	Compressor quantity		1INV	2INV	2INV	2INV	2INV	2INV	2INV	2INV	
	Refrigerant type		R410A	R410A	R410A	R410A	R410A	R410A	R410A	R410A	
	Refrigerant charge	kg	10	10	10	10	10	20	20	20	
	Refrigerant liquid pipe	mm	15.88	15.88	15.88	15.88	15.88	15.88	19.05	19.05	
	Refrigerant gas pipe	mm	28.58	28.58	28.58	28.58	28.58	28.58	31.8	31.8	
	Max.total pipe length	m	1000	1000	1000	1000	1000	1000	1000	1000	
	Max. pipe length (Equivalent/Actual)	m	260/220	260/220	260/220	260/220	260/220	260/220	260/220	260/220	
	Max drop between I.U.&O.U. (O.U. down/up) *1	m	110/90	110/90	110/90	110/90	110/90	110/90	110/90	110/90	
	Standard drop between I.U.&O.U. (O.U. up/down) *2	m	50/40	50/40	50/40	50/40	50/40	50/40	50/40	50/40	
Max drop between I.U. *3	m	30	30	30	30	30	30	30	30		
Standard drop between I.U. *4	m	18	18	18	18	18	18	18	18		
External static pressure	Pa	110	110	110	110	110	110	110	110		
Connection ratio	Connectable indoor unit ratio	%	50-130	50-130	50-130	50-130	50-130	50-130	50-130	50-130	
	Maximum number of indoor units		30	33	36	40	43	47	50	53	
Working temp.	Cooling	°C	-5-50			-5-50			-5-50		
	Heating	°C	-23-21			-23-21			-23-21		

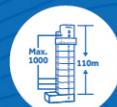

Total pipe length 1000m, height drop 110m



Auto addressing indoor units



Space saving



Better cooling capacity

Max drop between I.U.&O.U. *1
Standard drop between I.U.&O.U. *2
Max drop between I.U. *3
Standard drop between I.U. *4

If the height difference between the outdoor and the indoor units is from 50 to 110m, you MUST contact your local distributor/dealer for individual design and production. Standard design and production in the factory.
If the height difference between the indoor units is from 18 to 30m, you MUST contact your local distributor/dealer for individual design and production. Standard design and production in the factory.

* All the specifications are tested under nominal condition (in cooling, indoor temp. is 27°C DB/19°C WB; Outdoor temp 35°C DB/24WB in heating, indoor temp. is 20°C DB in heating, outdoor temp. is 7°C DB/6°CWB)

MRV5

DC INVERTER

3/380~415/50/60



AV08IMVEVA
AV10IMVEVA
AV12IMVEVA
AV14IMVEVA
AV16IMVEVA



AV18IMVEVA
AV20IMVEVA
AV22IMVEVA
AV24IMVEVA
AV26IMVEVA



Total pipe length 1000m,
height drop 110m



Auto addressing
indoor units



Space saving



Better cooling capacity

Model			AV34IMVEVA	AV36IMVEVA	AV38IMVEVA	AV40IMVEVA	AV42IMVEVA	AV44IMVEVA	AV46IMVEVA	
Combination model			AV16IMVEVA	AV18IMVEVA	AV18IMVEVA	AV20IMVEVA	AV20IMVEVA	AV22IMVEVA	AV22IMVEVA	
			AV18IMVEVA	AV18IMVEVA	AV20IMVEVA	AV20IMVEVA	AV22IMVEVA	AV22IMVEVA	AV24IMVEVA	
			/	/	/	/	/	/	/	
			/	/	/	/	/	/	/	
Capacity	Capacity range	HP	34	36	38	40	42	44	46	
	Cooling	kW	95.4	100.8	106.4	112.0	117.5	123.0	129.5	
	Heating	kW	95.4	100.8	106.4	112.0	117.5	123.0	129.5	
Electrical parameters	Power supply	Ph/V/Hz	3/380-415/50/60	3/380-415/50/60	3/380-415/50/60	3/380-415/50/60	3/380-415/50/60	3/380-415/50/60	3/380-415/50/60	
	Cooling	Rated power input	kW	28.94	31.40	32.32	33.23	34.92	36.61	40.24
		Max power input	kW	40.60	42.80	46.50	50.20	53.60	57.00	57.60
		Rated current	A	48.85	53.01	54.56	56.11	58.95	61.80	67.93
		Max current	A	68.54	72.26	78.50	84.75	90.49	96.23	97.24
	Heating	Rated power input	kW	24.44	26.39	27.85	29.32	31.28	33.24	36.05
		Max power input	kW	36.10	35.40	40.40	45.40	48.20	51.00	52.00
		Rated current	A	41.27	44.55	47.02	49.50	52.81	56.12	60.86
		Max current	A	60.94	59.76	68.20	76.64	81.37	86.10	87.79
	SEER			6.57	6.78	6.76	6.75	6.64	6.54	6.22
	SCOP			4.13	4.23	4.26	4.29	4.29	4.30	4.27
ηs.c	%		260	268	267	267	262	259	246	
ηs.h	%		162	166	167	168	169	169	168	
Performance	Air flow (H)	m³/h	30500	34000	34000	34000	35000	36000	36000	
	Sound pressure level (H)	dB(A)	63.5	64	64	64	64	64	64.5	
Installation	External dimensions(W/D/H)	mm	980/750/1690+1410/750/1690			1410/750/1690+1410/750/1690				
	Shipping dimensions(W/D/H)	mm	1070/850/1858+1515/850/1858			1515/850/1858+1515/850/1858				
	Net/Shipping weight	kg	244/270+287/317	287/317+287/317	287/317+370/400	370/400+370/400	370/400+370/400	370/400+370/400	370/400+370/400	
	Compressor type		DC INV. SCROLL	DC INV. SCROLL	DC INV. SCROLL	DC INV. SCROLL	DC INV. SCROLL	DC INV. SCROLL	DC INV. SCROLL	
	Compressor brand		MITSUBISHI	MITSUBISHI	MITSUBISHI	MITSUBISHI	MITSUBISHI	MITSUBISHI	MITSUBISHI	
			ELECTRIC	ELECTRIC	ELECTRIC	ELECTRIC	ELECTRIC	ELECTRIC	ELECTRIC	
	Compressor quantity		2INV	2INV	3INV	4INV	4INV	4INV	4INV	
	Refrigerant type		R410A	R410A	R410A	R410A	R410A	R410A	R410A	
	Refrigerant charge	kg	20	20	20	20	20	20	20	
	Refrigerant liquid pipe	mm	19.05	19.05	19.05	19.05	19.05	19.05	19.05	
	Refrigerant gas pipe	mm	31.8	38.1	38.1	38.1	38.1	38.1	38.1	
	Max.total pipe length	m	1000	1000	1000	1000	1000	1000	1000	
	Max. pipe length (Equivalent/Actual)	m	260/220	260/220	260/220	260/220	260/220	260/220	260/220	
	Max drop between I.U.&O.U. (O.U. down/up) *1	m	110/90	110/90	110/90	110/90	110/90	110/90	110/90	
Standard drop between I.U.&O.U. (O.U. up/down) *2	m	50/40	50/40	50/40	50/40	50/40	50/40	50/40		
Max drop between I.U. *3	m	30	30	30	30	30	30	30		
Standard drop between I.U. *4	m	18	18	18	18	18	18	18		
External static pressure	Pa	110	110	110	110	110	110	110		
Connection ratio	Connectable indoor unit ratio	%	50-130	50-130	50-130	50-130	50-130	50-130	50-130	
	Maximum number of indoor units		56	59	63	64	64	64	64	
Working temp.	Cooling	°C	-5-50						-5-50	
	Heating	°C	-23-21						-23-21	

Max drop between I.U.&O.U. *1

Standard drop between I.U.&O.U. *2

Max drop between I.U. *3

Standard drop between I.U. *4

If the height difference between the outdoor and the indoor units is from 50 to 110m, you MUST contact your local distributor/dealer for individual design and production.

Standard design and production in the factory.

If the height difference between the indoor units is from 18 to 30m, you MUST contact your local distributor/dealer for individual design and production.

Standard design and production in the factory.

* All the specifications are tested under nominal condition (in cooling, indoor temp. is 27°C DB/19°C WB; Outdoor temp 35°C DB/24WB; in heating, indoor temp. is 20°C DB; in heating, outdoor temp. is 7°C DB/6°CWB)

MRV5

DC INVERTER

3/380~415/50/60



AV08IMVEVA
AV10IMVEVA
AV12IMVEVA
AV14IMVEVA
AV16IMVEVA



AV18IMVEVA
AV20IMVEVA
AV22IMVEVA
AV24IMVEVA
AV26IMVEVA

Model			AV48IMVEVA	AV50IMVEVA	AV52IMVEVA	AV54IMVEVA	AV56IMVEVA	AV58IMVEVA	AV60IMVEVA	
Combination model			AV24IMVEVA	AV24IMVEVA	AV26IMVEVA	AV18IMVEVA	AV18IMVEVA	AV18IMVEVA	AV20IMVEVA	
			AV24IMVEVA	AV26IMVEVA	AV26IMVEVA	AV18IMVEVA	AV18IMVEVA	AV20IMVEVA	AV20IMVEVA	
			/	/	/	AV18IMVEVA	AV20IMVEVA	AV20IMVEVA	AV20IMVEVA	
			/	/	/	/	/	/	/	
Capacity	Capacity range	HP	48	50	52	54	56	58	60	
	Cooling	kW	136.0	141.5	147.0	151.2	156.8	162.4	168.0	
	Heating	kW	136.0	141.5	147.0	151.2	156.8	162.4	168.0	
Electrical parameters	Power supply	Ph/V/Hz	3/380-415/50/60		3/380-415/50/60		3/380-415/50/60		3/380-415/50/60	
	Cooling	Rated power input	kW	43.87	46.68	49.49	47.10	48.02	48.94	49.85
		Max power input	kW	58.20	62.10	66.00	64.20	67.90	71.60	75.30
		Rated current	A	74.06	78.81	83.56	79.52	81.07	82.61	84.16
		Max current	A	98.25	104.93	111.60	108.38	114.63	120.88	127.12
	Heating	Rated power input	kW	38.86	41.70	44.55	39.58	41.05	42.51	43.98
		Max power input	kW	53.00	56.90	60.80	53.10	58.10	63.10	68.10
		Rated current	A	65.60	70.40	75.20	66.82	69.30	71.77	74.25
		Max current	A	89.48	96.06	102.64	89.64	98.08	106.53	114.97
	SEER		5.97	5.81	5.68	6.78	6.76	6.75	6.75	
SCOP		4.25	4.00	3.80	4.23	4.25	4.27	4.29		
ηs.c	%	236	229	224	268	268	267	267		
ηs.h	%	167	157	149	166	167	168	168		
Performance	Air flow (H)	m³/h	36000	37000	38000	51000	51000	51000	51000	
	Sound pressure level (H)	dB(A)	65	65	65	65.8	65.8	65.8	65.8	
Installation	External dimensions(W/D/H)	mm	1410/750/1690+1410/750/1690		1410/750/1690+1410/750/1690		1410/750/1690+1410/750/1690+1410/750/1690			
	Shipping dimensions(W/D/H)	mm	1515/850/1858+1515/850/1858		1515/850/1858+1515/850/1858		1515/850/1858+1515/850/1858+1515/850/1858			
	Net/Shipping weight	kg	370/400+370/400		370/400+370/400		287/317+287/317+287/317	287/317+287/317+370/400	287/317+370/400+370/400	370/400+370/400+370/400
	Compressor type		DC INV. SCROLL		DC INV. SCROLL	DC INV. SCROLL	DC INV. SCROLL	DC INV. SCROLL	DC INV. SCROLL	
	Compressor brand		MITSUBISHI ELECTRIC		MITSUBISHI ELECTRIC	MITSUBISHI ELECTRIC	MITSUBISHI ELECTRIC	MITSUBISHI ELECTRIC	MITSUBISHI ELECTRIC	
	Compressor quantity		4INV		4INV	4INV	3INV	4INV	5INV	6INV
	Refrigerant type		R410A		R410A	R410A	R410A	R410A	R410A	
	Refrigerant charge	kg	20		20	20	30	30	30	30
	Refrigerant liquid pipe	mm	19.05		19.05	19.05	19.05	19.05	19.05	19.05
	Refrigerant gas pipe	mm	38.1		38.1	38.1	38.1	38.1	41.3	41.3
Max.total pipe length	m	1000		1000	1000	1000	1000	1000	1000	
Max. pipe length (Equivalent/Actual)	m	260/220		260/220	260/220	260/220	260/220	260/220	260/220	
Max drop between I.U.&O.U. (O.U. down/up) *1	m	110/90		110/90	110/90	110/90	110/90	110/90	110/90	
Standard drop between I.U.&O.U. (O.U. up/down) *2	m	50/40		50/40	50/40	50/40	50/40	50/40	50/40	
Max drop between I.U. *3	m	30		30	30	30	30	30	30	
Standard drop between I.U. *4	m	18		18	18	18	18	18	18	
External static pressure	Pa	110		110	110	110	110	110	110	
Connection ratio	Connectable indoor unit ratio	%	50-130		50-130	50-130	50-130	50-130	50-130	
	Maximum number of indoor units		64		64	64	64	64	64	
Working temp.	Cooling	°C	-5-50		-5-50					
	Heating	°C	-23-21		-23-21					

Max drop between I.U.&O.U. *1
Standard drop between I.U.&O.U. *2
Max drop between I.U. *3
Standard drop between I.U. *4

If the height difference between the outdoor and the indoor units is from 50 to 110m, you MUST contact your local distributor/dealer for individual design and production. Standard design and production in the factory.
If the height difference between the indoor units is from 18 to 30m, you MUST contact your local distributor/dealer for individual design and production. Standard design and production in the factory.

* All the specifications are tested under nominal condition (in cooling, indoor temp. is 27°C DB/19°C WB, outdoor temp. is 35°C DB/24°C WB; in heating, indoor temp. is 20°C DB, outdoor temp. is 7°C DB/6°C WB)

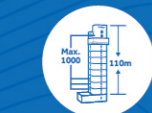

Total pipe length 1000m, height drop 110m



Auto addressing indoor units



Space saving



Better cooling capacity

MRV5

DC INVERTER

3/380~415/50/60



AV08IMVEVA
AV10IMVEVA
AV12IMVEVA
AV14IMVEVA
AV16IMVEVA



AV18IMVEVA
AV20IMVEVA
AV22IMVEVA
AV24IMVEVA
AV26IMVEVA



Model			AV62IMVEVA	AV64IMVEVA	AV66IMVEVA	AV68IMVEVA	AV70IMVEVA	AV72IMVEVA	AV74IMVEVA	
Combination model			AV22IMVEVA	AV22IMVEVA	AV22IMVEVA	AV22IMVEVA	AV22IMVEVA	AV24IMVEVA	AV26IMVEVA	
			AV20IMVEVA	AV22IMVEVA	AV22IMVEVA	AV22IMVEVA	AV24IMVEVA	AV24IMVEVA	AV24IMVEVA	
			AV20IMVEVA	AV20IMVEVA	AV22IMVEVA	AV24IMVEVA	AV24IMVEVA	AV24IMVEVA	AV24IMVEVA	
			/	/	/	/	/	/	/	
Capacity	Capacity range	HP	62	64	66	68	70	72	74	
	Cooling	kW	173.5	179.0	184.5	191.0	197.5	204.0	209.5	
	Heating	kW	173.5	179.0	184.5	191.0	197.5	204.0	209.5	
Electrical parameters	Power supply	Ph/V/Hz	3/380-415/50/60							
	Cooling	Rated power input	kW	51.54	53.22	54.91	58.54	62.17	65.81	68.62
		Max power input	kW	78.70	82.10	85.50	86.10	86.70	87.30	91.20
		Rated current	A	87.01	89.85	92.70	98.83	104.96	111.09	115.84
		Max current	A	132.86	138.60	144.34	145.35	146.37	147.38	154.05
	Heating	Rated power input	kW	45.94	47.90	49.86	52.67	55.48	58.29	61.13
		Max power input	kW	70.90	73.70	76.50	77.50	78.50	79.50	83.40
		Rated current	A	77.56	80.87	84.18	88.92	93.66	98.40	103.20
		Max current	A	119.69	124.42	129.15	130.84	132.52	134.21	140.80
	SEER		6.67	6.60	6.54	6.32	6.13	5.97	5.86	
SCOP		4.29	4.29	4.30	4.28	4.27	4.25	4.08		
ηs.c	%	264	261	259	250	242	236	231		
ηs.h	%	168	169	169	168	168	167	160		
Performance	Air flow (H)	m³/h	52000	53000	54000	54000	54000	54000	55000	
	Sound pressure level (H)	dB(A)	65.8	65.8	65.8	66	66.5	66.8	66.8	
Installation	External dimensions(W/D/H)	mm	1410/750/1690+1410/750/1690+1410/750/1690				1410/750/1690+1410/750/1690+1410/750/1690			
	Shipping dimensions(W/D/H)	mm	1515/850/1858+1515/850/1858+1515/850/1858				1515/850/1858+1515/850/1858+1515/850/1858			
	Net/Shipping weight	kg	370/400+370/400+370/400				370/400+370/400+370/400			
	Compressor type		DC INV. SCROLL				DC INV. SCROLL			
	Compressor brand		MITSUBISHI				MITSUBISHI			
	Compressor quantity		6INV				6INV			
	Refrigerant type		R410A				R410A			
	Refrigerant charge	kg	30				30			
	Refrigerant liquid pipe	mm	19.05				22.2			
	Refrigerant gas pipe	mm	41.3				44.5			
Max.total pipe lenth	m	1000				1000				
Max. pipe length (Equivalent/Actual)	m	260/220				260/220				
Max drop between I.U.&O.U. (O.U. down/up) *1	m	110/90				110/90				
Standard drop between I.U.&O.U. (O.U. up/down) *2	m	50/40				50/40				
Max drop between I.U. *3	m	30				30				
Standard drop between I.U. *4	m	18				18				
External static pressure	Pa	110				110				
Connection ratio	Connectable indoor unit ratio	%	50-130				50-130			
	Maximum number of indoor units		64				64			
Working temp.	Cooling	°C	-5-50				-5-50			
	Heating	°C	-23-21				-23-21			



Total pipe length 1000m, height drop 110m



Auto addressing indoor units



Space saving



Better cooling capacity

Max drop between I.U.&O.U. *1
Standard drop between I.U.&O.U. *2
Max drop between I.U. *3
Standard drop between I.U. *4

If the height difference between the outdoor and the indoor units is from 50 to 110m, you MUST contact your local distributor/dealer for individual design and production. Standard design and production in the factory.
If the height difference between the indoor units is from 18 to 30m, you MUST contact your local distributor/dealer for individual design and production. Standard design and production in the factory.

* All the specifications are tested under nominal condition (in cooling, indoor temp. is 27°C DB/19°C WB, outdoor temp 35°C DB/24WB in heating, indoor temp is 20°C DB in heating, outdoor temp is 7°C DB/6°CWB)

MRV5

DC INVERTER

3/380~415/50/60



AV08IMVEVA
AV10IMVEVA
AV12IMVEVA
AV14IMVEVA
AV16IMVEVA



AV18IMVEVA
AV20IMVEVA
AV22IMVEVA
AV24IMVEVA
AV26IMVEVA

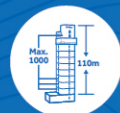

Total pipe length 1000m,
height drop 110m



Auto addressing
indoor units



Space saving



Better cooling capacity

Model			AV76IMVEVA	AV78IMVEVA	AV80IMVEVA	AV82IMVEVA	AV84IMVEVA	AV86IMVEVA	AV88IMVEVA	AV90IMVEVA	
Combination model			AV26IMVEVA	AV26IMVEVA	AV20IMVEVA	AV20IMVEVA	AV20IMVEVA	AV20IMVEVA	AV22IMVEVA	AV24IMVEVA	
			AV26IMVEVA	AV26IMVEVA	AV20IMVEVA	AV20IMVEVA	AV20IMVEVA	AV22IMVEVA	AV22IMVEVA	AV22IMVEVA	
			AV24IMVEVA	AV26IMVEVA	AV20IMVEVA	AV20IMVEVA	AV22IMVEVA	AV22IMVEVA	AV22IMVEVA	AV22IMVEVA	
			/	/	AV20IMVEVA	AV22IMVEVA	AV22IMVEVA	AV22IMVEVA	AV22IMVEVA	AV22IMVEVA	
Capacity	Capacity range	HP	76	78	80	82	84	86	88	90	
	Cooling	kW	215.0	220.5	224.0	229.5	235.0	240.5	246.0	252.5	
	Heating	kW	215.0	220.5	224.0	229.5	235.0	240.5	246.0	252.5	
Electrical parameters	Power supply	Ph/V/Hz	3/380-415/50/60	3/380-415/50/60	3/380-415/50/60	3/380-415/50/60	3/380-415/50/60	3/380-415/50/60	3/380-415/50/60	3/380-415/50/60	
	Cooling	Rated power input	kW	71.43	74.24	66.47	68.16	69.84	71.53	73.21	76.85
		Max power input	kW	95.10	99.00	100.40	103.80	107.20	110.60	114.00	114.60
		Rated current	A	120.59	125.34	112.21	115.06	117.91	120.75	123.60	129.73
		Max current	A	160.73	167.40	169.50	175.24	180.98	186.72	192.46	193.47
	Heating	Rated power input	kW	63.97	66.82	58.64	60.60	62.56	64.52	66.49	69.29
		Max power input	kW	87.30	91.20	90.80	93.60	96.40	99.20	102.00	103.00
		Rated current	A	108.00	112.80	98.99	102.31	105.62	108.93	112.24	116.98
		Max current	A	147.38	153.96	153.29	158.02	162.74	167.47	172.20	173.89
	SEER		5.76	5.68	6.75	6.69	6.64	6.59	6.54	6.37	
SCOP		3.93	3.80	4.29	4.29	4.29	4.29	4.30	4.29		
ηs,c	%	228	224	267	265	262	260	259	252		
ηs,h	%	154	149	168	168	169	169	169	169		
Performance	Air flow (H)	m³/h	56000	57000	68000	69000	70000	71000	72000	72000	
	Sound pressure level (H)	dB(A)	66.8	66.8	67	67	67	67	67	67.5	
Installation	External dimensions(W/D/H)	mm	1410/750/1690+1410/750/1690+1410/750/1690			1410/750/1690+1410/750/1690+1410/750/1690					
	Shipping dimensions(W/D/H)	mm	1515/850/1858+1515/850/1858+1515/850/1858			1515/850/1858+1515/850/1858+1515/850/1858					
	Net/Shipping weight	kg	370/400+370/400+370/400			370/400+370/400+370/400+370/400					
	Compressor type		DC INV. SCROLL	DC INV. SCROLL	DC INV. SCROLL	DC INV. SCROLL	DC INV. SCROLL	DC INV. SCROLL	DC INV. SCROLL	DC INV. SCROLL	
	Compressor brand		MITSUBISHI ELECTRIC	MITSUBISHI ELECTRIC	MITSUBISHI ELECTRIC	MITSUBISHI ELECTRIC	MITSUBISHI ELECTRIC	MITSUBISHI ELECTRIC	MITSUBISHI ELECTRIC	MITSUBISHI ELECTRIC	
	Compressor quantity		6INV	6INV	8INV	8INV	8INV	8INV	8INV	8INV	
	Refrigerant type		R410A	R410A	R410A	R410A	R410A	R410A	R410A	R410A	
	Refrigerant charge	kg	30	30	40	40	40	40	40	40	
	Refrigerant liquid pipe	mm	22.2	22.2	22.2	22.2	22.2	25.4	25.4	25.4	
	Refrigerant gas pipe	mm	44.5	44.5	44.5	44.5	44.5	50.8	50.8	50.8	
Max.total pipe length	m	1000	1000	1000	1000	1000	1000	1000	1000		
Max. pipe length (Equivalent/Actual)	m	260/220	260/220	260/220	260/220	260/220	260/220	260/220	260/220		
Max drop between I.U.&O.U. (O.U. down/up) *1	m	110/90	110/90	110/90	110/90	110/90	110/90	110/90	110/90		
Standard drop between I.U.&O.U. (O.U. up/down) *2	m	50/40	50/40	50/40	50/40	50/40	50/40	50/40	50/40		
Max drop between I.U. *3	m	30	30	30	30	30	30	30	30		
Standard drop between I.U. *4	m	18	18	18	18	18	18	18	18		
External static pressure	Pa	110	110	110	110	110	110	110	110		
Connection ratio	Connectable indoor unit ratio	%	50-130	50-130	50-130	50-130	50-130	50-130	50-130	50-130	
	Maximum number of indoor units		64	64	64	64	64	64	64	64	
Working temp.	Cooling	°C	-5-50			-5-50					
	Heating	°C	-23-21			-23-21					

Max drop between I.U.&O.U. *1
Standard drop between I.U.&O.U. *2
Max drop between I.U. *3
Standard drop between I.U. *4

If the height difference between the outdoor and the indoor units is from 50 to 110m, you MUST contact your local distributor/dealer for individual design and production.
Standard design and production in the factory.
If the height difference between the indoor units is from 18 to 30m, you MUST contact your local distributor/dealer for individual design and production.
Standard design and production in the factory.

* All the specifications are tested under nominal condition (cooling, indoor temp. is 27°C DB/19°C WB, outdoor temp 35°C DB/24WB in heating, indoor temp. is 20°C DB in heating, outdoor temp. is 7°C DB/6°CWB)

MRV5

DC INVERTER

3/380~415/50/60



AV08IMVEVA
AV10IMVEVA
AV12IMVEVA
AV14IMVEVA
AV16IMVEVA



AV18IMVEVA
AV20IMVEVA
AV22IMVEVA
AV24IMVEVA
AV26IMVEVA

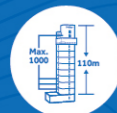

Total pipe length 1000m,
height drop 110m



Auto addressing
indoor units



Space saving



Better cooling capacity

Model			AV92IMVEVA	AV94IMVEVA	AV96IMVEVA	AV98IMVEVA	AV100IMVEVA	AV102IMVEVA	AV104IMVEVA	
Combination model			AV24IMVEVA	AV24IMVEVA	AV24IMVEVA	AV26IMVEVA	AV26IMVEVA	AV26IMVEVA	AV26IMVEVA	
			AV24IMVEVA	AV24IMVEVA	AV24IMVEVA	AV24IMVEVA	AV26IMVEVA	AV26IMVEVA	AV26IMVEVA	
			AV22IMVEVA	AV24IMVEVA	AV24IMVEVA	AV24IMVEVA	AV24IMVEVA	AV26IMVEVA	AV26IMVEVA	
			AV22IMVEVA	AV22IMVEVA	AV24IMVEVA	AV24IMVEVA	AV24IMVEVA	AV24IMVEVA	AV26IMVEVA	
Capacity	Capacity range	HP	92	94	96	98	100	102	104	
	Cooling	kW	259.0	265.5	272.0	277.5	283.0	288.5	294.0	
	Heating	kW	259.0	265.5	272.0	277.5	283.0	288.5	294.0	
Electrical parameters	Power supply	Ph/V/Hz	3/380-415/50/60	3/380-415/50/60	3/380-415/50/60	3/380-415/50/60	3/380-415/50/60	3/380-415/50/60	3/380-415/50/60	
	Cooling	Rated power input	kW	80.48	84.11	87.74	90.55	93.37	96.18	98.99
		Max power input	kW	115.20	115.80	116.40	120.30	124.20	128.10	132.00
		Rated current	A	135.86	142.00	148.13	152.87	157.62	162.37	167.12
		Max current	A	194.48	195.49	196.51	203.18	209.85	216.53	223.20
	Heating	Rated power input	kW	72.10	74.91	77.71	80.56	83.40	86.25	89.09
		Max power input	kW	104.00	105.00	106.00	109.90	113.80	117.70	121.60
		Rated current	A	121.72	126.46	131.20	136.00	140.80	145.60	150.40
		Max current	A	175.57	177.26	178.95	185.53	192.12	198.70	205.29
	SEER		6.22	6.09	5.97	5.89	5.81	5.74	5.68	
SCOP		4.27	4.26	4.25	4.12	4.00	3.90	3.80		
ηs.c	%	246	241	236	232	229	227	224		
ηs.h	%	168	167	167	162	157	153	149		
Performance	Air flow (H)	m³/h	72000	72000	72000	73000	74000	75000	76000	
	Sound pressure level (H)	dB(A)	67.5	68	68	68	68	68	68	
Installation	External dimensions(W/D/H)	mm	1410/750/1690+1410/750/1690+1410/750/1690+1410/750/1690							
	Shipping dimensions(W/D/H)	mm	1515/850/1858+1515/850/1858+1515/850/1858+1515/850/1858							
	Net/Shipping weight	kg	370/400+370/400+370/400+370/400							
	Compressor type		DC INV. SCROLL	DC INV. SCROLL	DC INV. SCROLL	DC INV. SCROLL	DC INV. SCROLL	DC INV. SCROLL	DC INV. SCROLL	
	Compressor brand		MITSUBISHI	MITSUBISHI	MITSUBISHI	MITSUBISHI	MITSUBISHI	MITSUBISHI	MITSUBISHI	
	Compressor quantity		8INV	8INV	8INV	8INV	8INV	8INV	8INV	
	Refrigerant type		R410A	R410A	R410A	R410A	R410A	R410A	R410A	
	Refrigerant charge	kg	40	40	40	40	40	40	40	
	Refrigerant liquid pipe	mm	25.4	25.4	25.4	25.4	25.4	25.4	25.4	
	Refrigerant gas pipe	mm	50.8	50.8	50.8	54.1	54.1	54.1	54.1	
Max.total pipe length	m	1000	1000	1000	1000	1000	1000	1000		
Max. pipe length (Equivalent/Actual)	m	260/220	260/220	260/220	260/220	260/220	260/220	260/220		
Max drop between I.U.&O.U. (O.U. down/up) *1	m	110/90	110/90	110/90	110/90	110/90	110/90	110/90		
Standard drop between I.U.&O.U. (O.U. up/down) *2	m	50/40	50/40	50/40	50/40	50/40	50/40	50/40		
Max drop between I.U. *3	m	30	30	30	30	30	30	30		
Standard drop between I.U. *4	m	18	18	18	18	18	18	18		
External static pressure	Pa	110	110	110	110	110	110	110		
Connection ratio	Connectable indoor unit ratio	%	50-130	50-130	50-130	50-130	50-130	50-130	50-130	
	Maximum number of indoor units		64	64	64	64	64	64	64	
Working temp.	Cooling	°C	-5-50							
	Heating	°C	-23-21							

Max drop between I.U.&O.U. *1
Standard drop between I.U.&O.U. *2
Max drop between I.U. *3
Standard drop between I.U. *4

If the height difference between the outdoor and the indoor units is from 50 to 110m, you MUST contact your local distributor/dealer for individual design and production.
Standard design and production in the factory.
If the height difference between the indoor units is from 18 to 30m, you MUST contact your local distributor/dealer for individual design and production.
Standard design and production in the factory.

* All the specifications are tested under nominal condition (in cooling, indoor temp. is 27°C DB/19°C WB, outdoor temp. is 35°C DB/24°C WB, in heating, indoor temp. is 20°C DB, in heating, outdoor temp. is 7°C DB/6°C WB)

Dimensions

AV08IMVEVA AV10IMVEVA AV12IMVEVA AV14IMVEVA AV16IMVEVA

Unit:mm

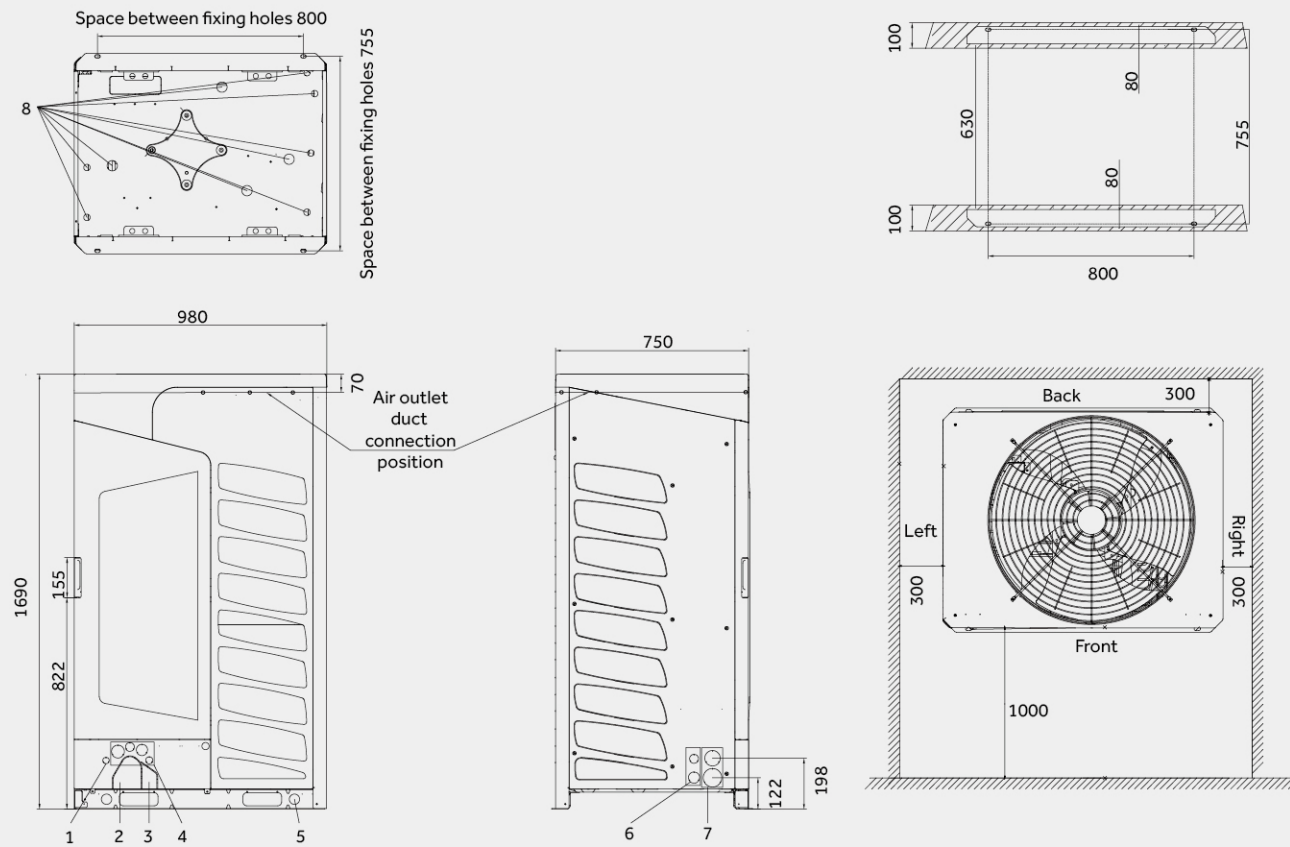

AV18IMVEVA AV20IMVEVA AV22IMVEVA AV24IMVEVA AV26IMVEVA

Unit:mm

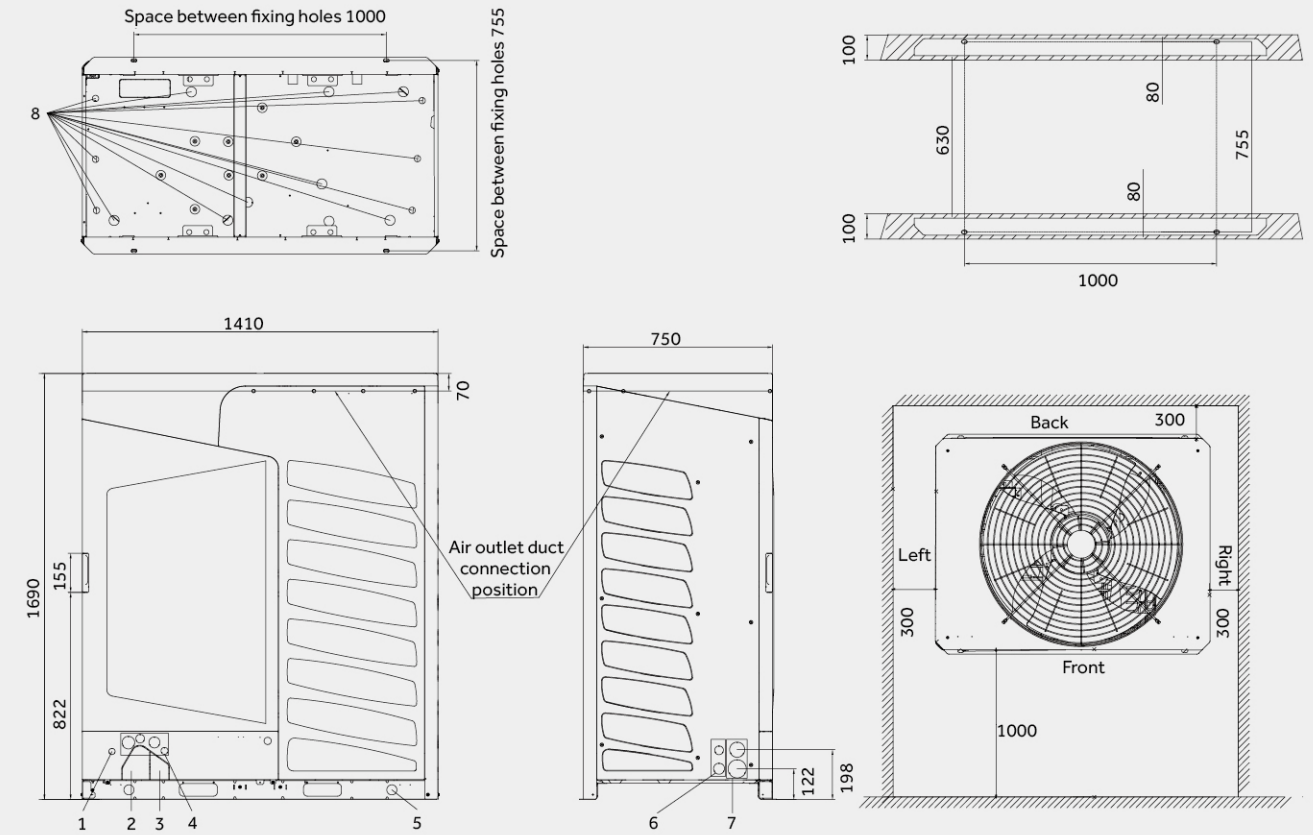

No.	Name	Remark
1	Signal line hole Ø25	Using the rubber plug in the unit's attachment for protection
2	Pipe outlet for 2-pipe system	
3	Pipe outlet for 3-pipe system	
4	Power supply hole	According to the wire diameter size to choose the appropriate line hole, and using the line sheath in the unit's attachment for protection
5	Hoisting hole	
6	Power supply of signal line hole	
7	Refrigerant pipe outlet	
8	Drain hole	

No.	Name	Remark
1	Signal line hole Ø25	Using the rubber plug in the unit's attachment for protection
2	Pipe outlet for 2-pipe system	
3	Pipe outlet for 3-pipe system	
4	Power supply hole	According to the wire diameter size to choose the appropriate line hole, and using the line sheath in the unit's attachment for protection
5	Hoisting hole	
6	Power supply of signal line hole	
7	Refrigerant pipe outlet	
8	Drain hole	